

## Technical Specification

Model : HD85V5 Machine weight : 8,100kg Operating weight : 8,175kg  
 Bucket capacity : 0.11m<sup>3</sup> ~ 0.28m<sup>3</sup> [Standard 0.25m<sup>3</sup>]

### ENGINE

Model ..... YANMAR 4TNV98C  
 Rated output ..... 42.7kW/2,100min-1  
 Max. torque ..... 235N · m/1,365min-1

### DIMENSIONS

Overall length ..... 6,050mm  
 Overall height ..... 2,630mm  
 Overall width ..... 2,200mm  
 Max. ground clearance ..... 350mm  
 Tail slewing radius ..... 1,400mm  
 Crawler length ..... 2,730mm  
 Shoe width ..... 450mm

### TRAVEL&SWING SYSTEM

Travel speed ..... 2.5/4.4km/h  
 Max. swing speed ..... 9.0min-1  
 Grade ability ..... 58% (30°)  
 Ground pressure ..... 38kPa(0.39kgf/cm<sup>2</sup>)

### DIGGING FORCE

Bucket digging force ..... 55.0kN  
 Arm digging force ..... 39.0kN

### CAPACITY

Hydraulic tank ..... 75L (reference capacity)  
 Fuel tank ..... 110L

### HYDRAULIC SYSTEM

Pumps ..... Double variable piston pump and gear pump  
 Swing motor ..... Constant displacement piston type with swing brake  
 Travel motor ..... Variable displacement plunger motor  
 Control valves ..... 11 section multiple control valves  
 Max. pressure/ setting ..... 24.5MPa (250kgf/cm<sup>2</sup>)

### DIMENSION (mm)

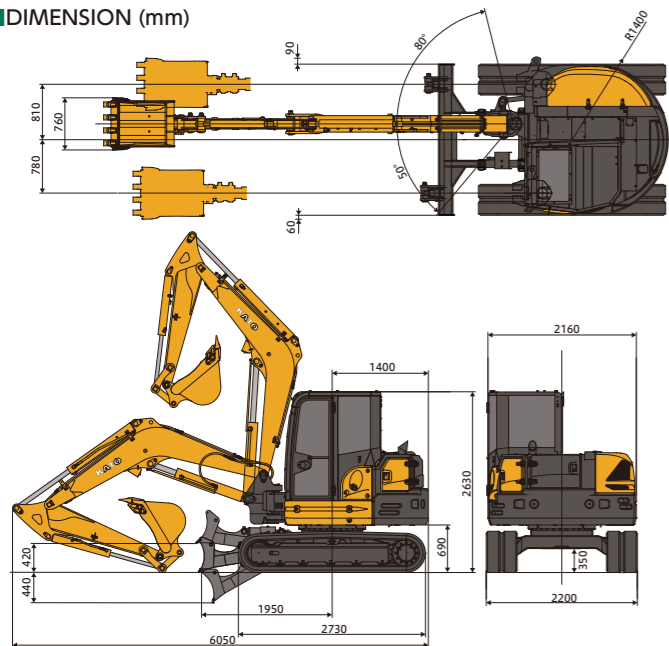

### WORKING RANGE (mm) [Standard/Long arm]

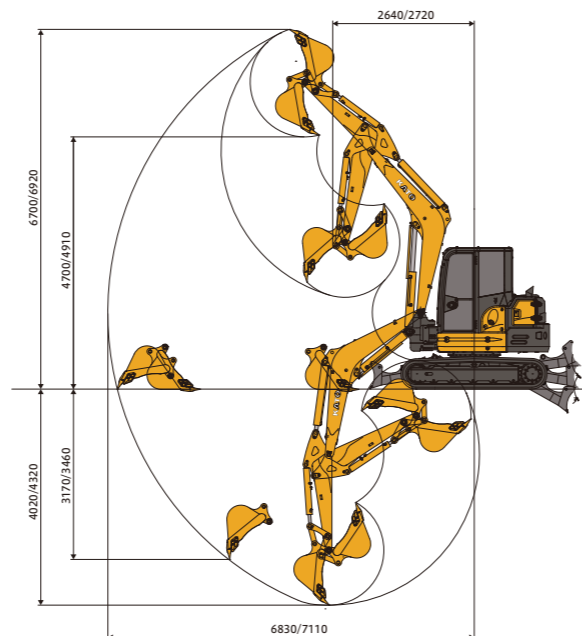

### STANDARD AND OPTIONAL EQUIPMENT

○ : Standard ● : Optional

#### Safety equipment

Cabin(ROPS)	○
OPG	○
All-lever lock structure (Neutral engine-start system)	○
Retractable seat-belt	○
Boom working light ※1	○
LED boom working light ※1	○
Front and Rear working light	○
Rear side mirror	○
Automatic parking brake (slewing table)	○
Automatic parking brake (traveling)	○
Caution indication	○
Swing table under cover	○
Reinforced hose(partial)	○
Rear side reflective plate	○
Engine fan guard	○
Secondary engine stop switch	○
Front guard	○
Traveling alarm	○

#### Piping and others

Anti-burst valve	○
1st aux. piping for attachment (W/A selectable) ※3	○
2nd aux. piping for attachment ※4	○
3rd aux. piping for attachment	○
Aux. piping proportional control	○
Stop valve	○
Accumulator	○
Pattern change valve (ABCD)	○
Pattern change valve (AF)	○
Designated paint	○
Relief valve for aux port (13.7MPa)	○
Relief valve for aux port (17.2MPa)	○
Relief valve for aux port (20.6MPa)	○

#### Working equipment

Bucket	0.11m <sup>3</sup>	○
	0.16m <sup>3</sup>	○
	0.21m <sup>3</sup>	○
	0.25m <sup>3</sup>	○
Arm	STD Arm	○
	Long Arm (+300mm)	○
Dozer blade	Reinforced type	○
	Additional counterweight(+340kg)	○

#### Traveling equipment

Shoe	450mm rubber shoe	○
	450mm steel shoe	○
Traveling frame undercover		○

#### Operation seat

12V electric supply port	○
Cup holder	○
Arm rest	○
Electric control throttle knob	○
Multiple one-key	○
Analogue monitor	○
Seat suspension	○

#### System

Mode selection (Vmax mode/ ECO mode)	○
Auto-idling mode	○
Auto transmission	○
Traveling speed 1 fixed mode	○

#### Maintenance

Outer fuel filler port	○
Double element air cleaner	○
Cartridge type return filter	○
Hydraulic oil tank with air breather system	○
Side by side cooling	○
Large fuel filter	○
Water separator with electric sensor	○
Dustproof net in front of radiator	○
Castle nut for adjustment (boom tip)	○
Castle nut for adjustment (arm link)	○
Engine error code display	○
Engine diagnosis CAN service connector	○
Tool set	○
Electric refueling pump	○

### SPECIFICATION AND COMBINATION OF BUCKET

Type	Bucket				
Bucket capacity (JIS M3) (m <sup>3</sup> )	0.11	0.16	0.21	0.25	0.28
Bucket width (mm)	without side cutter	365	465	565	675
	with side cutter	450	550	650	760
Number of bucket teeth	3	3	4	4	4
Standard arm	○	○	○	○	○
Long arm	○	○	○	○	○

●:General purpose □:Light work ×:Unusable

### SHOE

Type	Rubber	Steel
Shoe width (mm)	450	
Overall width (mm)	2,200	
Ground pressure (kPa)	38	

- ※1 Cannot be installed at the same time
- ※2 Cannot be installed at the same time
- ※3 Control is proportional
- ※4 2nd or 2nd and 3rd aux piping cannot be selected without the 1st aux piping

- Before using this machine, read the instruction manual precautions thoroughly to operate it correctly
- Specifications are subject to change without notice for improvement purposes
- Photographs shown in the catalog were taken for publication and therefore may differ in some cases from actual objects
- When operating the excavator, wear clothing and equipment in accordance to local legal and safety regulations.

● Contact for enquiry:



**KATO WORKS CO.,LTD.**

9-37, Higashi-ohi 1-chome, Shinagawa-ku, Tokyo, 140-0011, Japan  
 Tel.: Head Office: Tokyo +81 (0)3 3458-1111

Overseas Marketing Department: Tokyo +81 (0)3 3458-1115 / FAX: Tokyo +81 (0)3 3458-1163

www.kato-works.co.jp

QUALITY & EXPERIENCE  
 SINCE 1895



**KATO**

# HYDRAULIC EXCAVATOR

# V FIVE HD 85



Great stability and high performance

# Powerful Strong Reliable

It established both workability and compactness

## Workability

### Enhancement of Stability

Stability is enhanced in comparison to the previous model by lowering the center of gravity. The workability has been improved for efficient operation.



### Wide Boom Swing Range

The swing angle is 80 degrees to the right and 50 degrees to the left. Wide range of excavation is possible and can be useful for digging grooves on the shoulders of roads. The front attachment is lighter than zero tail swing machine. It secures stability and also covers heavy duty.

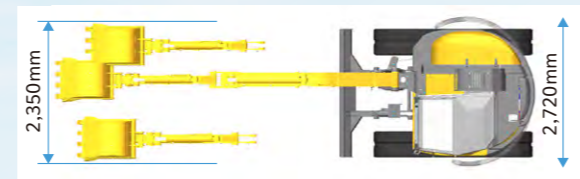

### High Power Digging and Quick Response

It adopts a new high-performance main pump that enhances and provides great workability. It is powerful, has great response and good for multiple operation.

- Swing force is enhanced by 14%UP (in comparison to 80VX3)
- Dumping height is increased by 7%UP (in comparison to 80VX3)

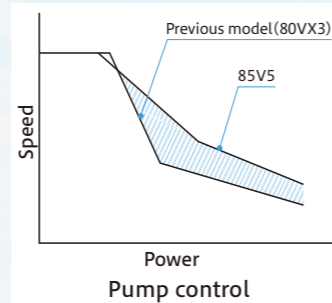
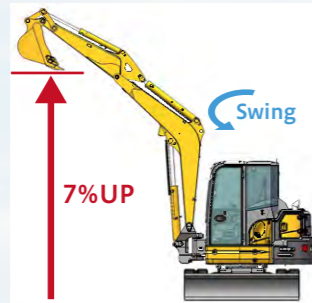

### Compact Tail Swing

The tail swing radius is only 300mm over from the crawler. It secures stability more than Zero Tail Swing.



### Long Digging Radius

The digging radius is long enough to approach wide range and securely perform the dumping.

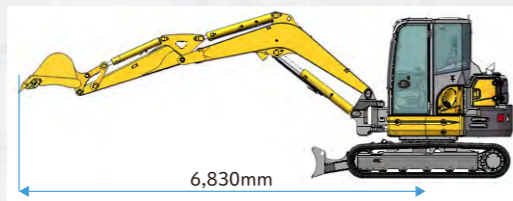

### Fully Versatile Easy Skimming Work

The closer distance between bucket teeth and dozer blade allows it to skim the ground easier.



## Safety

### ROPS Compliant Cabin

This cabin is ROPS-compliant. It secures the safety and protection of the operator from roll-over accident.

### Engine Start System and Safety Lock System

The engine is turned on when that lever is in the neutral position. Auto-parking brake is activated when the lock lever is raised (Including dozer blade and swing). It offers high operation safety and prevents unexpected movements.

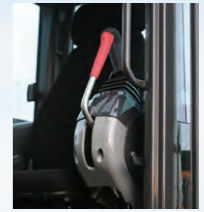

### Emergency Engine Stop Switch

It is possible to stop the engine from outside the cabin during an emergency.



### Excellent Visibility

A wide view is provided in the compact body. The right front view is wide and maximizes the boom swing. The side and rear mirrors allow you to monitor the surrounding conditions and work safely. ※Mirror is optional



## Economy

### Environment Friendly Engine

The engine is compliant to EU StageV and EPA Tier4 final. The DPF greatly reduces PM and the water-cooled EGR suppresses the NOx.

### Enhanced Economy

Isochronous control system maintains the engine speed even if the workload changes. Fuel consumption is reduced in comparison to the previous model.



### Vmax Mode and ECO Mode

Operation mode is selectable from Vmax mode, which is operation speed oriented. ECO mode that ensures low fuel consumption.

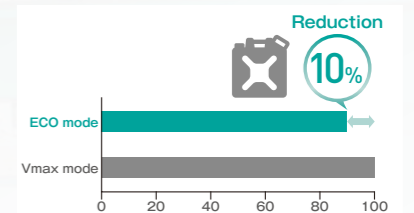

### Auto-idling is Standard Feature

Optimum engine speed is engaged automatically in few seconds after returning the operation lever to neutral position. It saves fuel consumption by approx. 10%.

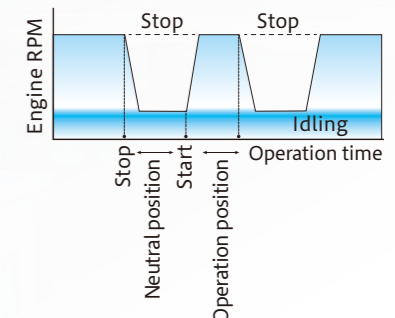

# Durability



### Working Light Under The Boom

The light installed under the boom is protected from damage.



### Reinforced Boom Cylinder Cover

The V-shaped double structure reinforced boom cylinder cover protects the cylinder from damages.



### Boom Swing Pin

Single large size pin reduces the wearing and rattling sounds.

### Removable Side Cover

The separated side covers are removable and easy to maintain. The lower cover that is susceptible damage is repairable.

### Reinforced Dozer Blade

Dozer blade arm adopts sturdy square tube structure. It is strong and durable against twist.



### Door Protection

When wide open, the door tip fits into the counterweight, preventing door damage.



### Cover Protection

The cover is placed inside of the counter weight and is protected from damage.



※Image shows additional counterweight

# Comfortability

### Comfortable Operating Station

This spacious operating station reduces operator's fatigue.



### Suspension Seat

The seat height and suspension are adjustable.

### Front Window with Damper Assistance

It is easily openable thanks to damper assistance.



### Window Storage Rack

It can store the front window.



### Rear Storage Space



### Large Capacity Storage Under The Seat



### 12V Electric Supply Port

Equipped with an electric supply port. (12V 10A)



### Monitor with Engine Error Code Display

Brand new monitor with improved visibility of display thanks to the always lit LED light. Display of engine error code, supports efficient maintenance.

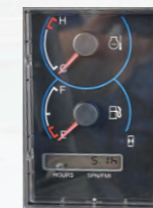

Light lever (1st Aux. port)

### Traveling Auto-shifting Mode

Traveling speed 1 and 2 are automatically changed according to the traveling motor load. Speed 1 can only be set by operating the switch on the dozer lever.

### Double Proportional Control

The spare port can be operated with the switch on the grip. It improved operability thanks to hand operation without using pedals. Operation for 1st spare port is with the right lever grip, 2nd spare port is with the left one. ※2nd spare port is optional



Left lever (2nd Aux. port)

### Centralized switches



Cup holder

# Maintenance

## Good Access to Service Ports

Fully-opening rear and right-side covers give you a good access to the engine and other service ports.



### Easy Refueling

The fuel filler port is placed at an outer position for easy refueling without cover opening.

### DPF Muffler

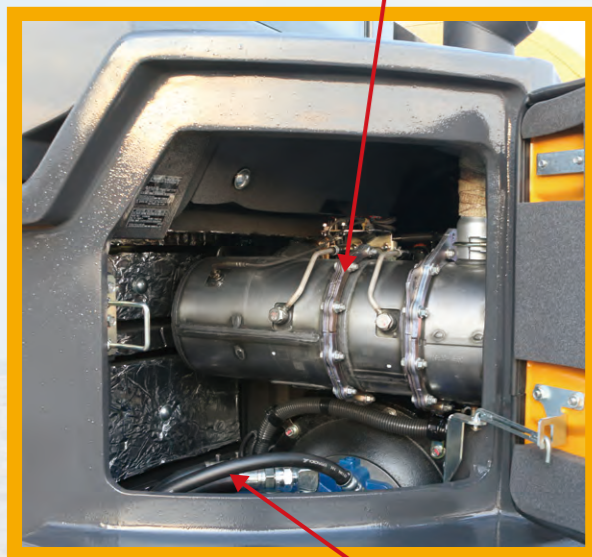

### Hydraulic Pump

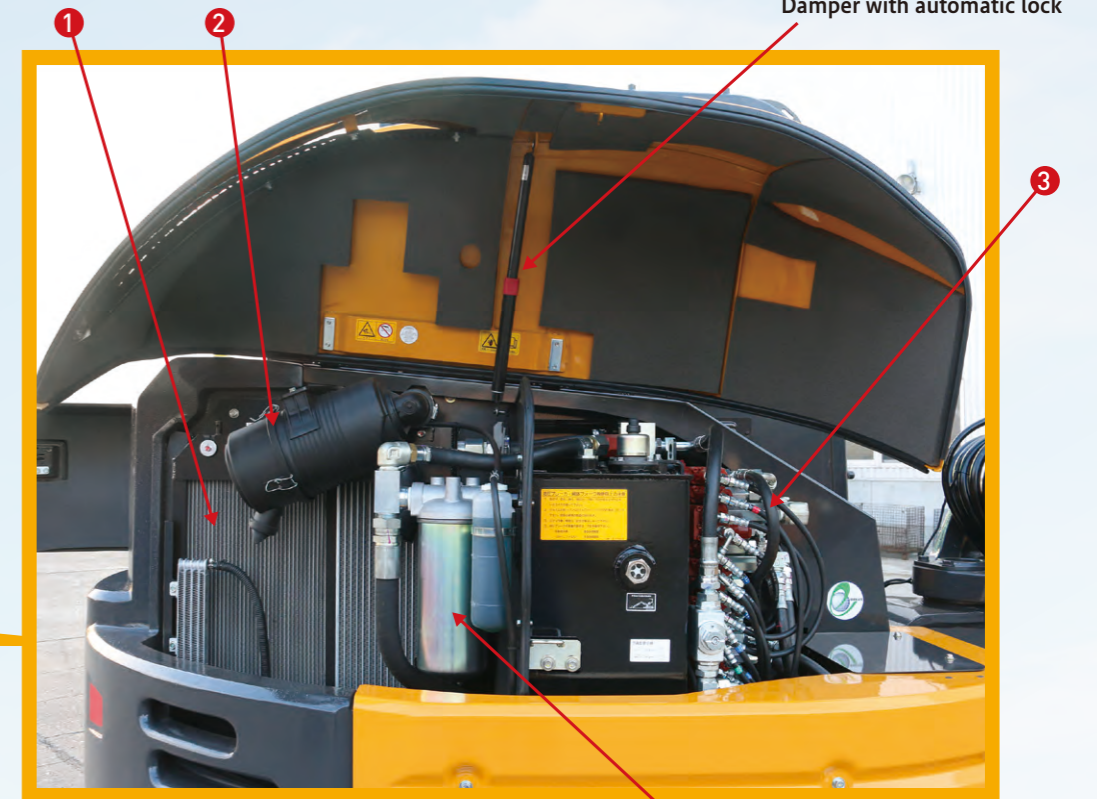
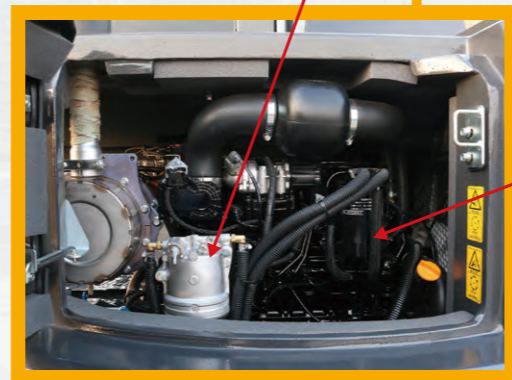

- 1 Side by side cooling
- 2 Air cleaner (Double element)
- 3 Control valve
- 4 Hydraulic oil return filter

### Cartridge Type Return Filter

Adopts cartridge type hydraulic oil return filter. It is easily changeable, protects from sand contamination, and offers time reduction for its change.

### DPF Automatic Regeneration

The computer identifies soot accumulation and burns automatically during the operation. There is no operation limit during the automatic regeneration. The automatic regeneration extends the interval of manual regeneration and enable it to operate for a longer time period.

※The interval of manual regeneration is depends on usage conditions.

### Outside Storage



- 5 Water separator with electric sensor
- 6 Fuel filter

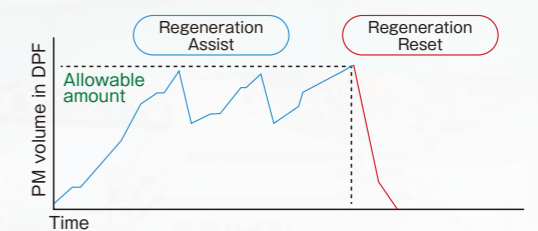

# Option

## Air Conditioner



## Heater



## Pattern change valve (ABCD)



## Traveling pedal



## Additional counter weight



## Steel shoe

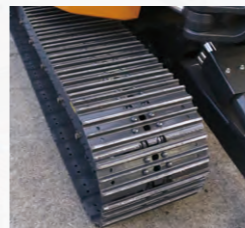

## Light for Cabin



## Long arm



## Proportional control lever



## Aux. piping

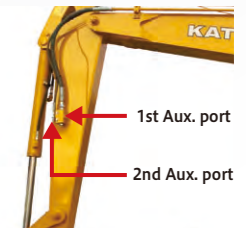

※1st Aux. port : Standard  
※2nd Aux. port : Option